

Compact, two-way passive cabinet. Consists of a 12" (3" voice coil) LF transducer and a 1" HF driver mounted on a 90° x 60° rotatable horn



Key features

- Compact two-way passive cabinet
- Multi-angle enclosure
- 90° x 60° rotatable horn
- Screwless grill with protective acoustic textile
- Integrated ergonomic handle
- Hidden speakon connection
- Top hat for pole mounting
- Multiple installations options, including stage monitor
- Polyurea coating

Applications

- Club & bar installation
- Houses of worship
- Sound reinforcement
- Theatres
- Public address
- Multi media spaces

General description & specifications

The BS-12 is a compact, two-way passive cabinet. Consists of a 12" (3" voice coil) LF transducer and a 1" HF driver mounted on a 90° x 60° rotatable horn offering a wide range of applications from fixed installations, frontfill and as a stage monitor.

The 12" driver offers high power handling and high sensitivity with low harmonic distortion and linear response. The cone is waterproof and has been treated on both sides. The ultra compact 1" HF driver achieves high sensitivity, with exceptional dynamic range creating remarkable depth and definition.

The cabinet can be complemented by the BS-112 or BS-118 subwoofers and offers tremendous sound and clarity over medium distances. Constructed from premium birch plywood and coated in high resistant polyurea paint. The enclosure also offers a screw free grille together with a number of dedicated accessories. Although the BS-12 can be used without a processor we recommend that the cabinet presets are applied for maximum optimization and performance.



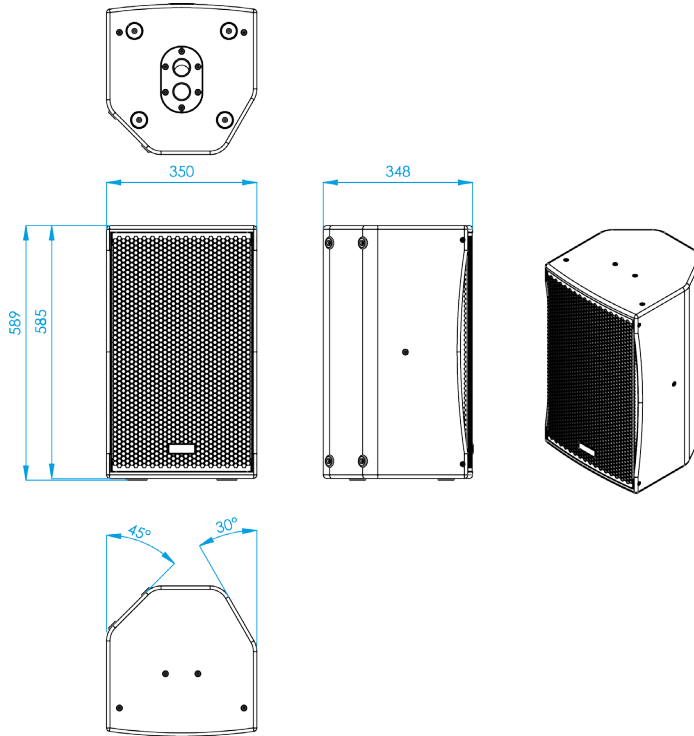

Technical Data

Components	
• LF:	12" speaker, 3" (75 mm) copper wire voice coil, Waterproof cone with treatment on both sides
• HF:	1" exit throat, (25,4 mm) voice coil, annular diaphragm driver
Frequency range	60 Hz - 20 KHz (-10dB)
Sensitivity	96 dB
Max SPL	122 dB / 128 dB
Rated Power	400 W AES (800 W program, 1600 W peak)
Dispersion	90° x 60° rotatable
Nominal Impedance	8 Ω
Connectors	2 x NEUTRIK Speakon NL4
Finish	Polyurea coating
Material	15 mm Premium birch plywood
Dimensions	589 x 350 x 348 mm (H x W x D)
Weight	19 Kg (41.8 lbs)
Fittings	5 x M8, double pole-mount with 10° angle, ergonomic handle on the back position
Accessories	U bracket horizontal & vertical, M8 eyebolts, wall bracket, M20 pole
Enclosure Type	Multi angle enclosure

Dimensional Drawing



Accessories

	AGR-8	M8 Eyebolt
	TU-C02	M20 pole support for combination between sub and satellite cabinet
	SB-02	Lightweight aluminium stand
	WB-20	Wall bracket for BS-12
	UBR-BS12	U bracket for BS-12

Impedance Response & Frequency Response

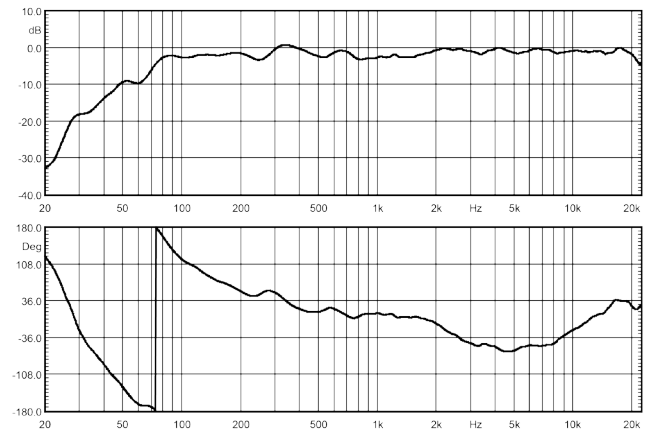
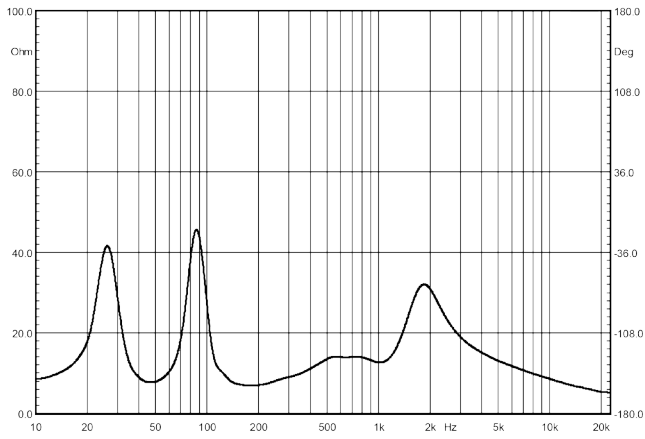

Model BS-12 Optimizer Preset

This document contains the filter values for the model BS-12 speaker.

NUMBER FILTER	TYPE OF FILTER	FREQ Hz	Q	GAIN dB
1	Parametric Q Adap	660	5	-3
2	Parametric Q Adap	63	2.4	4
3				
4				
5				
6				
7				
8				
9				

CROSSOVER	TYPE	FREQ Hz	GAIN dB
LOW-PASS			
HIGH-PASS	Buttw	30	3° 18 dB/Oct

Note:

The preset is made with an amplifier from the RS series and an ARK processor. Using other products will not guarantee the same result and if the preset is incorrectly introduced it can affect the performance of the system and the reliability of the speaker.

Ensure the impedance of the loudspeaker and the maximum AES power is capable of supporting when adjusting the power limitation in the amplifier.

This can also lead to loss of warranty claims in case of damage.

CULTURE OF SOUND