

# MASK12-BL

12" Two-way full range loudspeaker  
black



The famous Apart MASK Series, a standard in the fixed install audio industry for many years, has been expanded with a MASK12 cabinet loudspeaker. This new 12" two-way high power cabinet loudspeaker is very easy to install and can be used in many full range indoor applications where a medium to high sound pressure level is required. Think of bars, pubs or sports cafeterias where background music is played during the day but where in the evenings more powerful foreground music is needed. Next to that the MASK12 is also perfectly suited for fitness centres, sport halls or multipurpose rooms where the music needs to be cranked up during sports lessons or events.

The special shape of MASK12 allows easy installation close to the ceiling or at the wall in a horizontal or vertical position. Mounted vertically MASK12, has a nominal dispersion angle of 90°H x 70°V. When mounted horizontally, you can rotate the high frequency horn by 90° to keep the same horizontal dispersion angle. It doesn't matter how you mount the loudspeaker as the Apart logo on the loudspeaker can be rotated 360° degrees.

The cabinet of MASK12 is made of wood and has a steel grill.

The special U-bracket MASK12BRA is designed with the installer in mind and is therefore provided with an opening to hook up the MASK12 loudspeaker. The cabinet has fixation bolts already pre-mounted what allows the installer to hang the cabinet into the bracket easily. No more searching and fizzling when he is on top of his ladder. This special mounting system allows the installer to mount the loudspeaker in the correct position without worrying of the speaker falling down despite the 19kg weight of the loudspeaker. With Apart's MASK12PBRA pole mount you can install the loudspeaker easy on the wall.

The MASK12 loudspeakers will satisfy your customers in terms of sound quality, reliability and setup versatility. We recommend combining 4 MASK12 loudspeakers with the REVAMP2600 power amplifier and we assure that your sound system will be taken to a new level of performance!

## TECHNICAL SPECIFICATIONS

height in mm	628	width in mm	370
depth in mm	370	loudspeaker system	2-way
woofer size in inch	12	woofer cone material	paper
tweeter size in inch	1.4	opening angle	90°H x 70°V
mounting system	optional	rigging flying points	14 x M10
colour	black / white	impedance (ohms)	8
low impedance dynamic power in watts	700	low impedance RMS power in watts	350
SPL 1W/1m in dB	98	max SPL 1m in dB	127
frequency response in Hz	48 - 22K	main construction material	wood
grille main material	steel	IP rating	40
closest RAL colour (subject to deviations)	RAL9003 (W) / RAL9011 (BL)	Net weight product (kg)	19.10

## POLAR PLOTS

Data Shown: MASK12-70x90 (Apart Audio)  
 Display Parameters: Frequency: 1000Hz (1/24th Octave)

Horizontal  
 Vertical

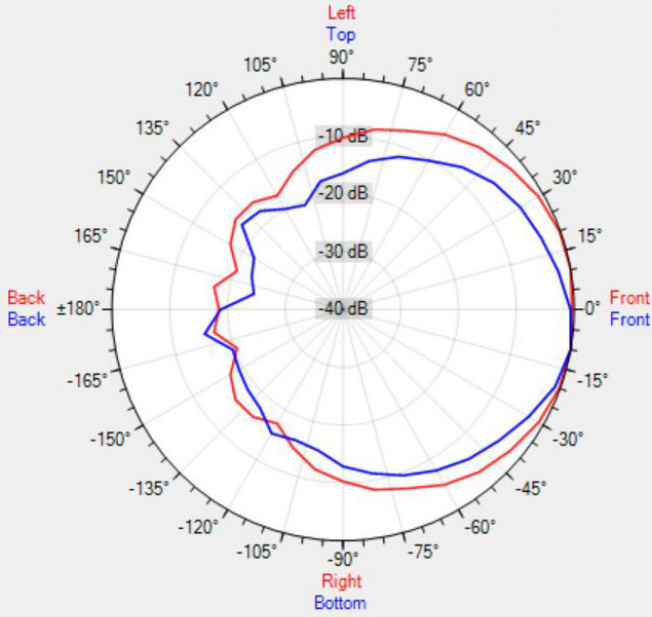

Data Shown: MASK12-70x90 (Apart Audio)  
 Display Parameters: Frequency: 2000Hz (1/24th Octave)

Horizontal  
 Vertical

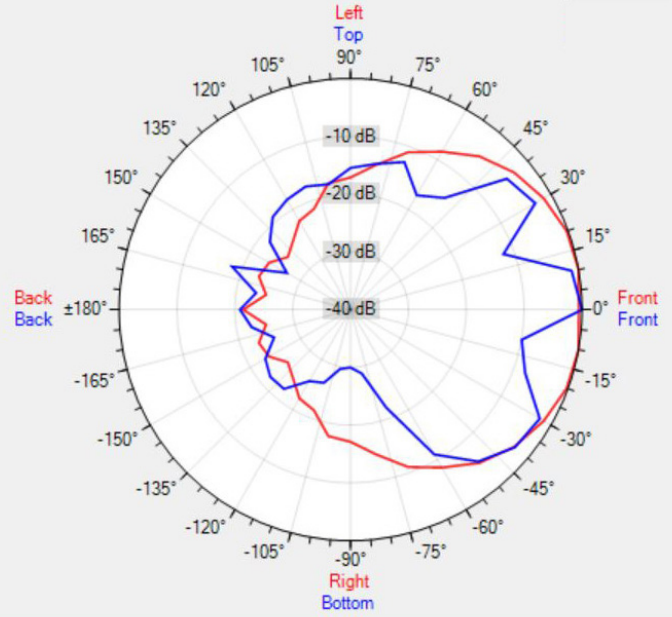

Data Shown: MASK12-70x90 (Apart Audio)  
 Display Parameters: Frequency: 4000Hz (1/24th Octave)

Horizontal  
 Vertical

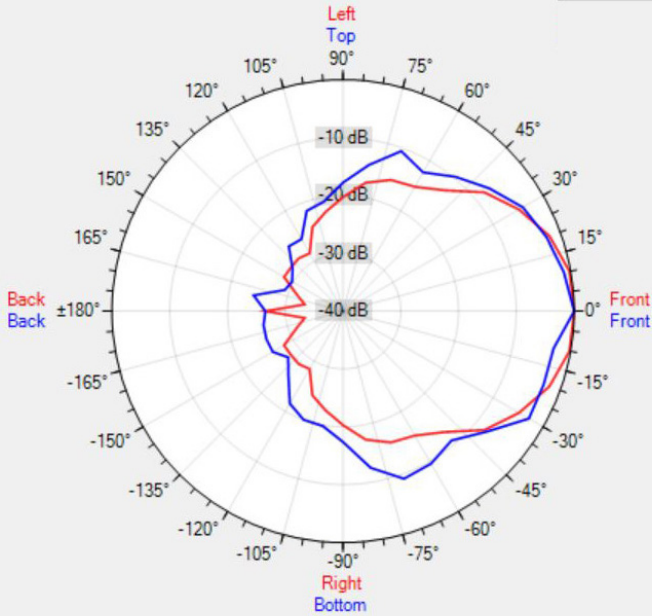

Data Shown: MASK12-70x90 (Apart Audio)  
 Display Parameters: Frequency: 8000Hz (1/24th Octave)

Horizontal  
 Vertical

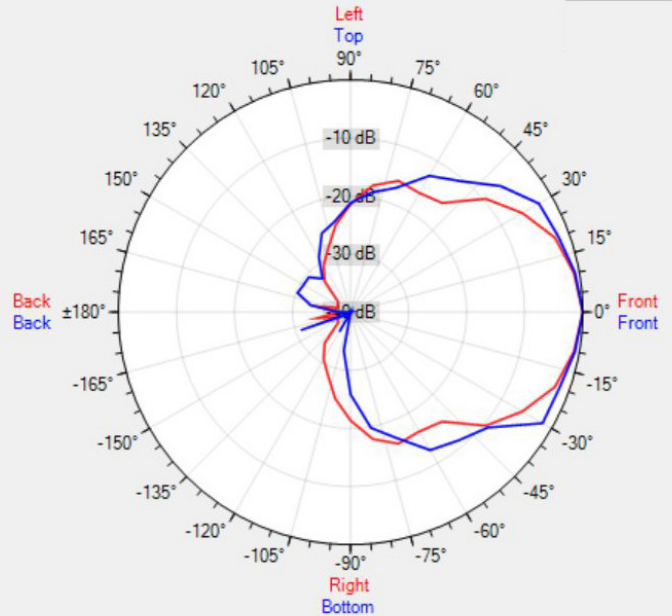

Data Shown: MASK12-90x70 (Apart Audio)  
Display Parameters: Frequency: 1000Hz (1/24th Octave)

— Horizontal  
— Vertical

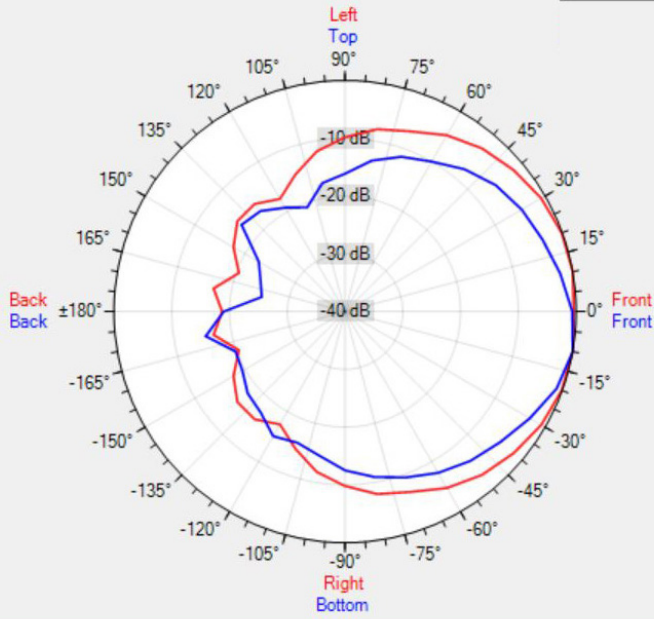

Data Shown: MASK12-90x70 (Apart Audio)  
Display Parameters: Frequency: 2000Hz (1/24th Octave)

— Horizontal  
— Vertical

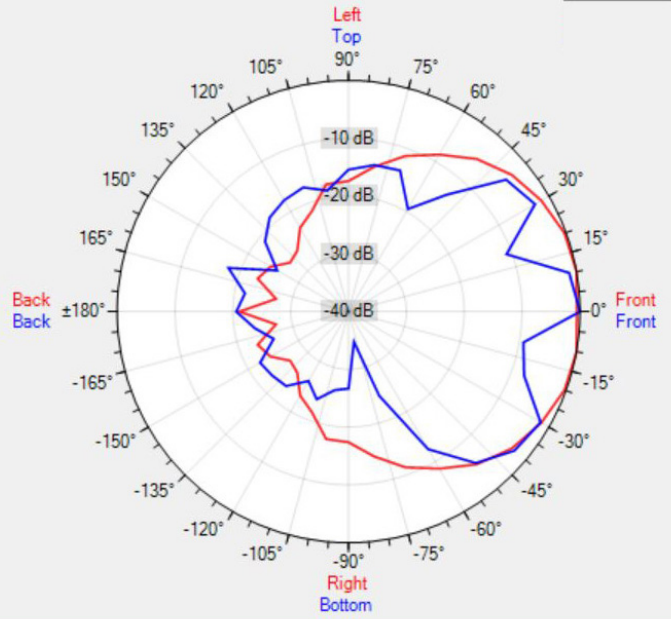

Data Shown: MASK12-90x70 (Apart Audio)  
Display Parameters: Frequency: 4000Hz (1/24th Octave)

— Horizontal  
— Vertical

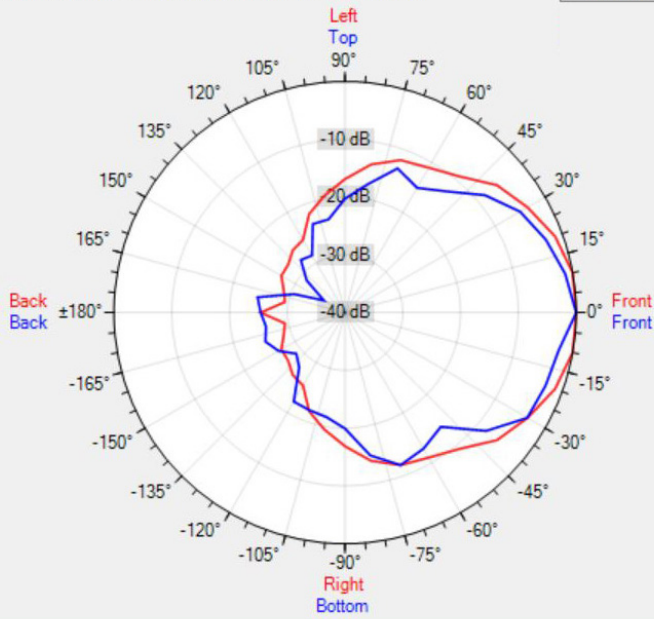

Data Shown: MASK12-90x70 (Apart Audio)  
Display Parameters: Frequency: 8000Hz (1/24th Octave)

— Horizontal  
— Vertical

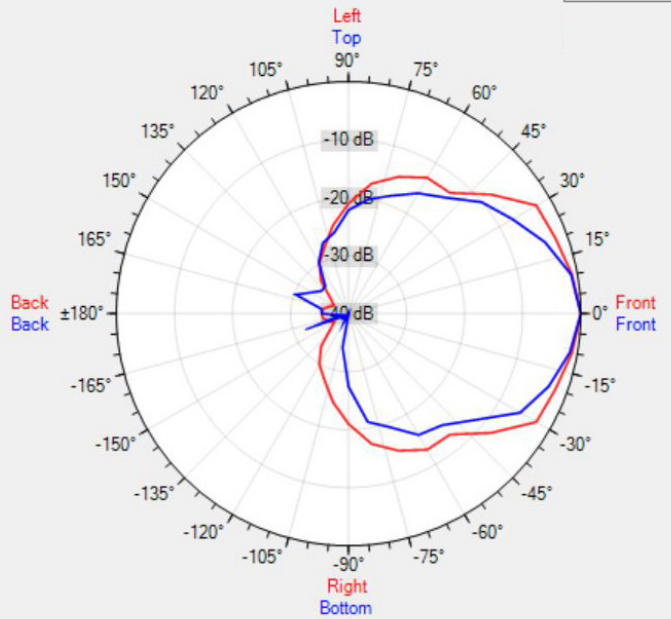



MORE PICTURES

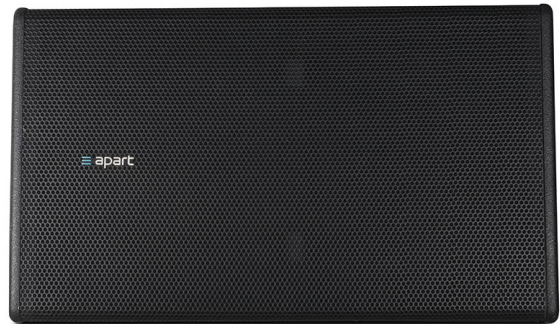
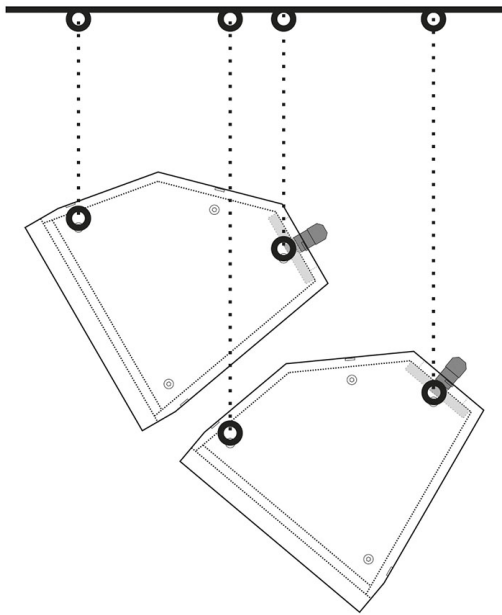
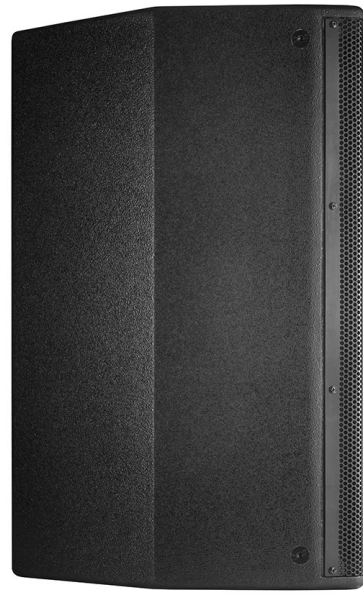



ACCESSORIES

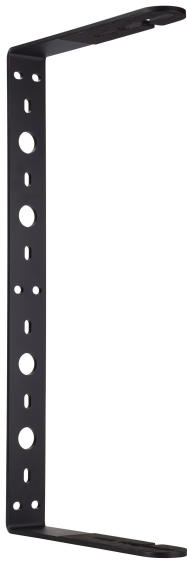

**MASK12UBRA-BL**  
Mounting U-bracket for MASK12-BL



**MASK12PBRA-BL**  
pole bracket for MASK12 and MASK12T